

Introduction

The purpose of this paper is to discuss the characteristics of splitters and microfilters for VDSL2 applications. Both CPE configurations are simplified into an equivalent loop representation in order to more easily compare the characteristics that will most significantly affect VDSL2 performance, specifically impedance changes due to the presence of bridge taps and loading of the LINE in the DSL frequency band.

Splitters and Microfilters: An Overview

In typical DSL deployments, Voice and DSL services are provide over the same line of twisted-pair copper wires. The copper wires carry signals with frequencies up to 30MHz (VDSL2), enabling customer data rates of more than 100Mbps. The figure below illustrates an example of a VDSL2 band-plan:

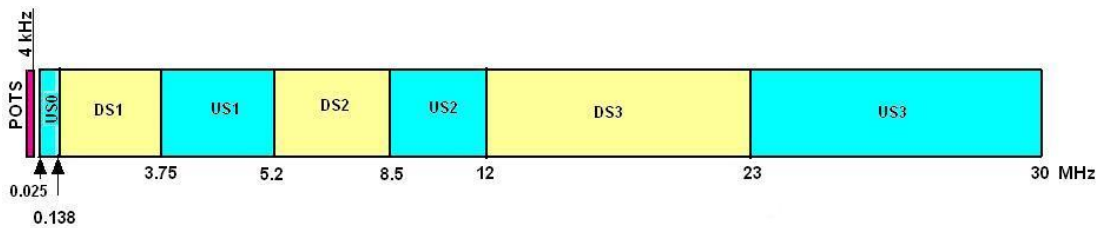

Figure 1: VDSL2 Band Plan Distribution (US Upstream, DS Downstream)

As seen above, the line at the customer’s premises contains voice signals (POTS- lower frequency range up to 4 kHz) for the telephone as well as data signals (higher frequency range 25 kHz – 30 MHz) for DSL services. Signals intended for DSL service disrupt the service of the voice calls. More importantly, phone transient events disrupt DSL service making it is essential to isolate the low frequency POTS signal from DSL signals.

At the Customer Premise, isolation between POTS signals and DSL signals is most commonly achieved by installing either a single CPE splitter or multiple microfilters (also known as in-line filters).

Microfilters

A Microfilter is a Low-Pass Filter (LPF) that isolates the low frequency signals on the line from the high frequency (DSL) signals and prevents interference between the two. Microfilters have Line and POTS ports and are typically installed 'in-line' with telephones, fax machines and/or answering machines, and can be easily installed by the customer.

Figure 2 shows a typical household loop configuration with microfilters. The loop is defined by main segment L1 from the central office to the Line Port at the customer premises, L5 segment from the Line Port at the home to the modem, and additional line segments (bridge taps) L2, L3, and L4 which connect the line port with 3 inline filters. (Note: These segments may represent one of three connections: 1) an in-line filter terminated with a telephonic device; 2) an un-terminated in line-filter; or, 3) un-terminated telephone wiring in the home.). It should be noted that in-line filters are connected in parallel with the line to the modem; a parallel connection with the line has a very high possibility of significantly changing the impedance of the line.

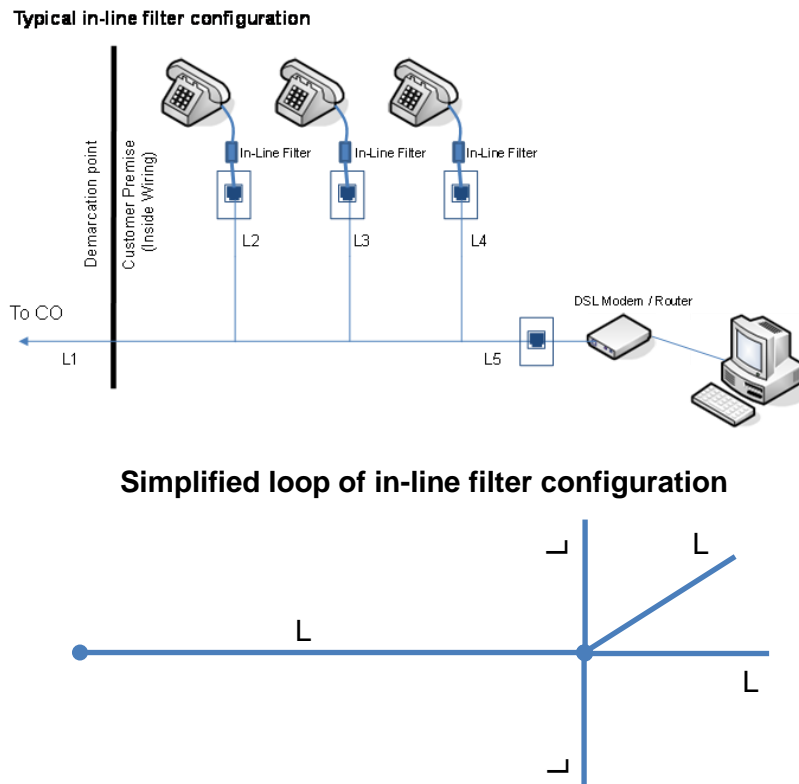

Figure 2: Typical loop configuration with multiple in-line filter installation

CPE Splitter

A CPE splitter has 3 connections: Line, DSL and POTS. It provides low pass filtering between the Line Port and POTS port and a HPF (high pass filter) or all pass filter between Line and DSL ports.

A typical Loop configuration of CPE splitter installation is shown in Figure 3. In this situation the loop for DSL signal is defined by main segment L1 between the central office and the Line Port at the home, and short segment L5 between Line Port and modem. It should be noted that segments L2, L3, L4 do not represent bridge taps to L1 and L5 because they are isolated by the CPE splitter.

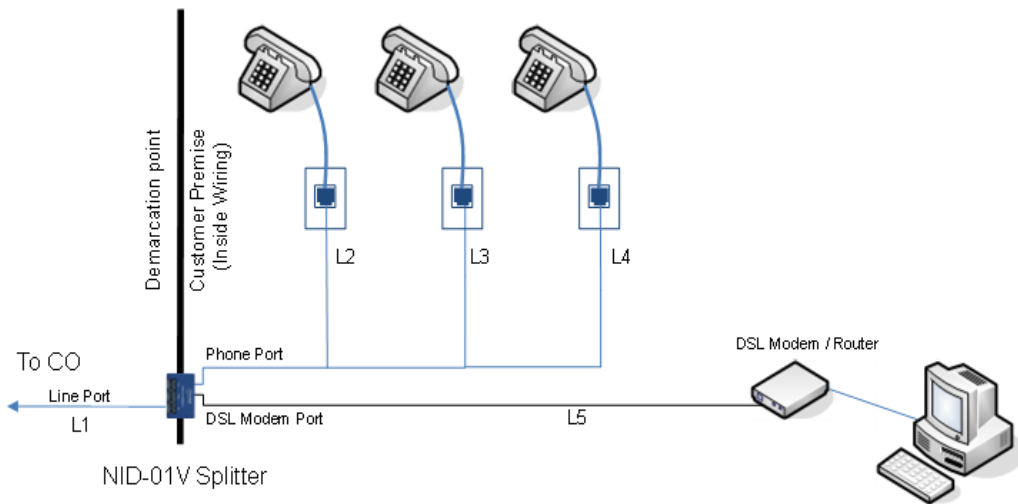

Figure 3: Typical Loop configuration in a CPE Splitter installation

CPE Splitter vs. In-Line filters

Comparing the installation configurations of a CPE Splitter (Figure 3) and multiple in-line filters (Figure 2), two main differences are noticed:

- A multiple In-Line filter installation has an equivalent loop with bridge taps, whereas a CPE Splitter installation has an equivalent straight line loop that eliminates bridge taps within the home.
- Multiple In-Line filters are connected in parallel with line, while only one CPE splitter is connected to the line; therefore the resultant loading effect on the line is greater with in-line filters than with a CPE splitter.

Bridge (Bridged) Tap

A bridge tap is an un-terminated branch in a cable, or any branch on a pair that is not a direct connection between the Line and the subscriber. For the purpose of this paper, we will refer to any 'T' connection in the copper pairs as a bridge tap, be it un-terminated or terminated (with microfilter and/or telephone equipment).

Any signal transmitted on the main copper pair will also travel down the bridge tap. Open end of the bridge tap (or high impedance when filter is installed) will result of the signal being reflected back towards the main copper pair. In the voice band this reflection will result in echo; in the DSL band it will lower attainable data rates.

In the case of longer bridge taps (20- 40 ft) very drastic changes in data rates will occur due to significant changes in insertion loss and impedance. Impedance comparison for the two installation options is shown in Figure 4. Ideal input impedance to the modem is 100 Ohms.

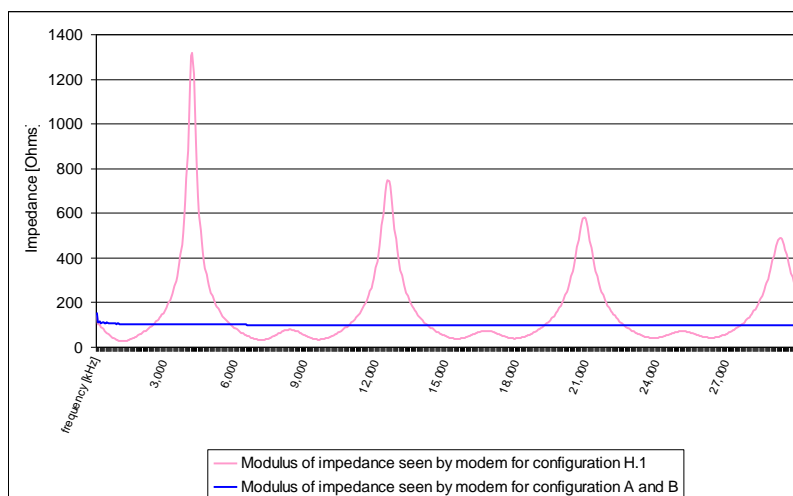

Figure 4: Difference of impedance to the modem for Loops with in-line filters with in line filters vs CPE splitter with configuration found in Appendix C

Calculations show that with an in-line filter configuration, bridge tap segments of just 3ft in length can change the impedance seen by the modem more than 50%. This change in impedance will result in high reflection and a smaller amount of power transferred to the modem; results will be significantly decreased VDSL2 data rates. Data rates will not be similarly affected with a CPE splitter due to the fact that the CPE splitter eliminates bridge taps, separating DSL and POTS at the input of home network.

In a configuration using in-line filters such as shown in the diagram below. A bridge tap of 40 ft would create notches (highest loss of the signal) around 4 MHz, 12 MHz, 20 MHz and 29 MHz. This would lead to downstream and/or upstream degradation depending upon what bands are impacted by the notches.

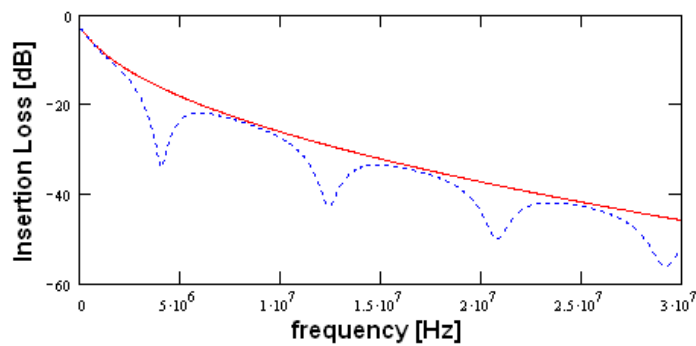
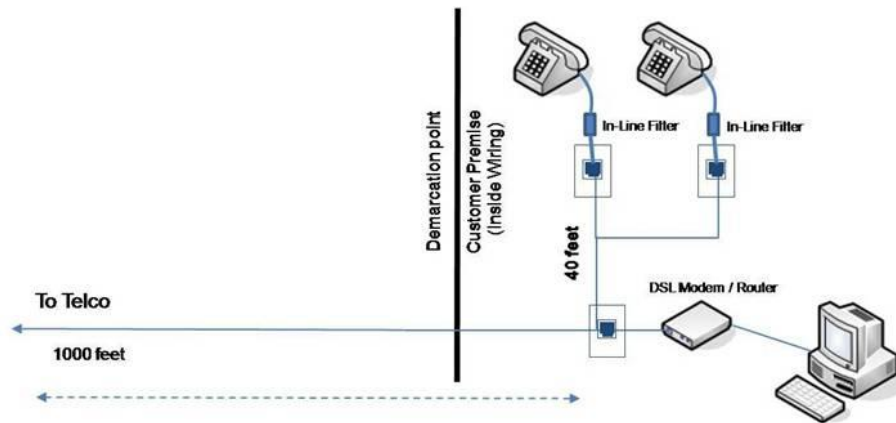
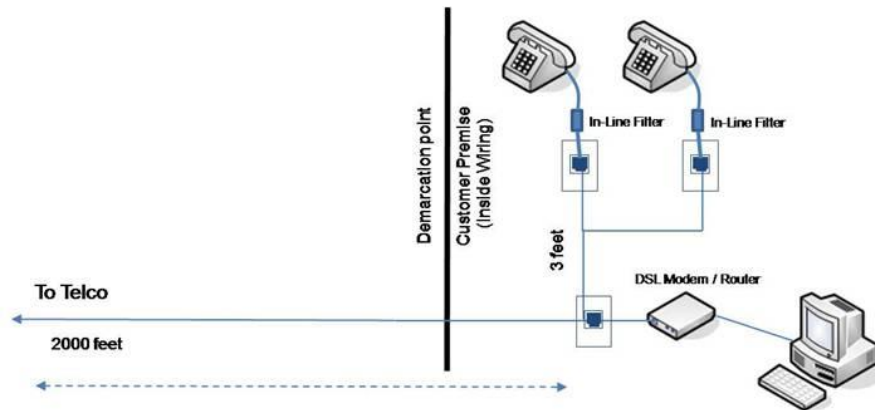

Figure 5: Insertion loss notches corresponding with a 40 foot bridge tap

Data rate comparison between configurations using CPE Splitter vs in-line microfilter

Using a 2000 foot loop from the Telco Office to the Customer Premise:

- In-line filter configuration with a **3 foot bridge TAP** between modem and phone line in-line filter as shown below. Measured *25% degradation* in downstream data rate compared to configuration using a CPE Splitter.



- In-line filter configuration with a **20 foot bridge TAP** between modem and phone line in-line filter as shown below. Measured *45% degradation* in downstream data rate compared to configuration using a CPE Splitter.

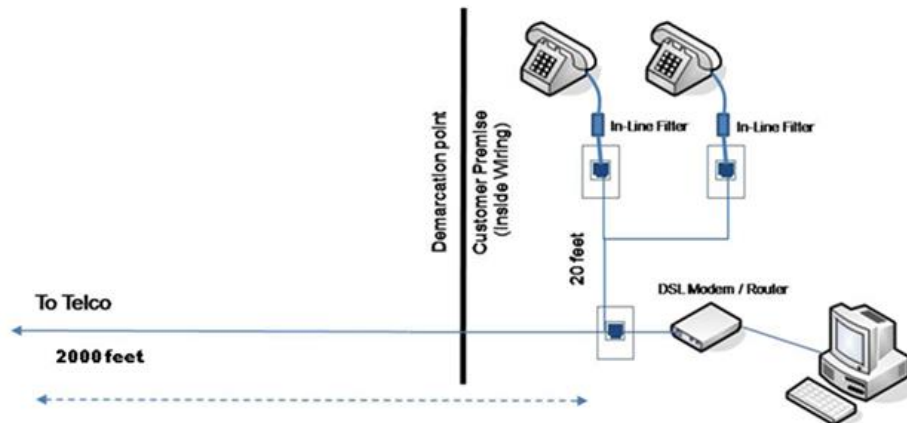



VDSL2 POTS Splitters and Microfilters

Measured data rates using typical home wiring configurations

The following tables compare measured VDSL2 training rates (17a profile) with CPE splitters and various in-line filter configurations. Refer to Appendices A, B and C for diagrams of the in-line filter installations.

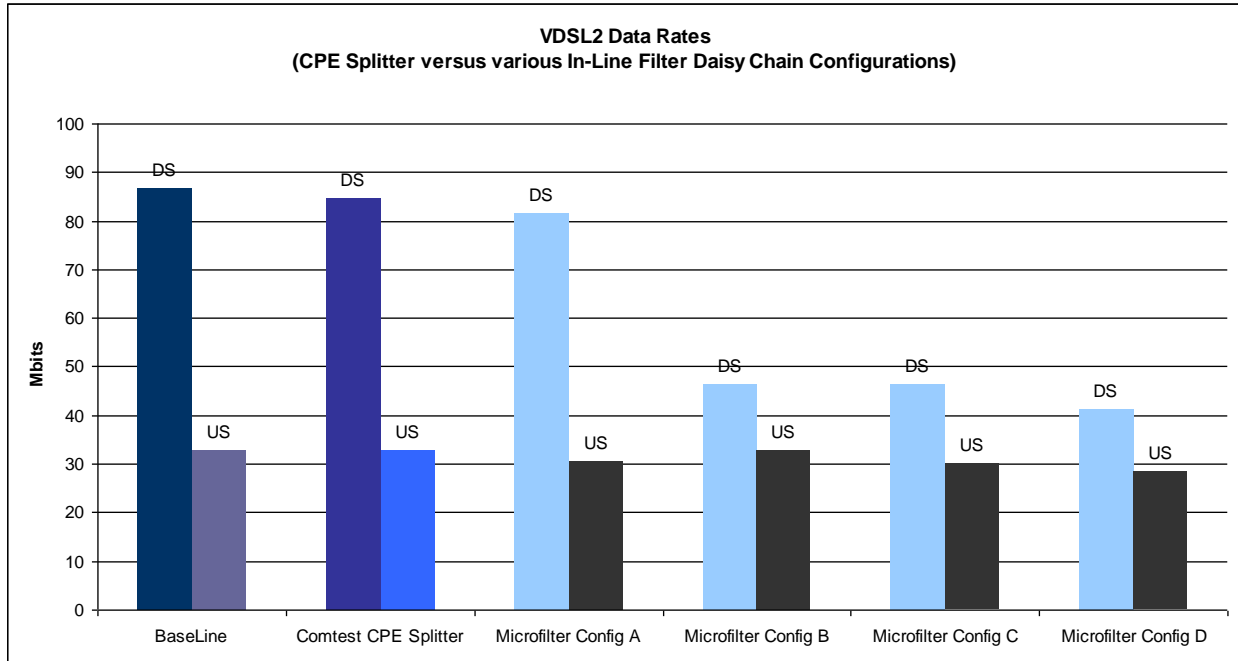

- NID-01V A NID-01V splitter placed at beginning of chain. Chain extends from POTS port of NID-01V. DSL Modem is home run from DSL Port
- Config A Daisy chain in-line filters 20 ft apart. Last jack has Wall Mount DSL filter with modem.
- Config B Daisy chain in-line filters 20 ft apart. First jack of chain has Wall Mount DSL filter with Modem
- Config C Daisy chain of POTS jacks 20 ft apart. First jack of chain has Wall Mount DSL filter with Modem
- Config D Daisy chain in-line filters 20 ft apart. 4th jack of chain has Wall Mount DSL filter with Modem

* See Appendix A Daisy Chain Configuration for details on Configurations



VDSL2 POTS Splitters and Microfilters

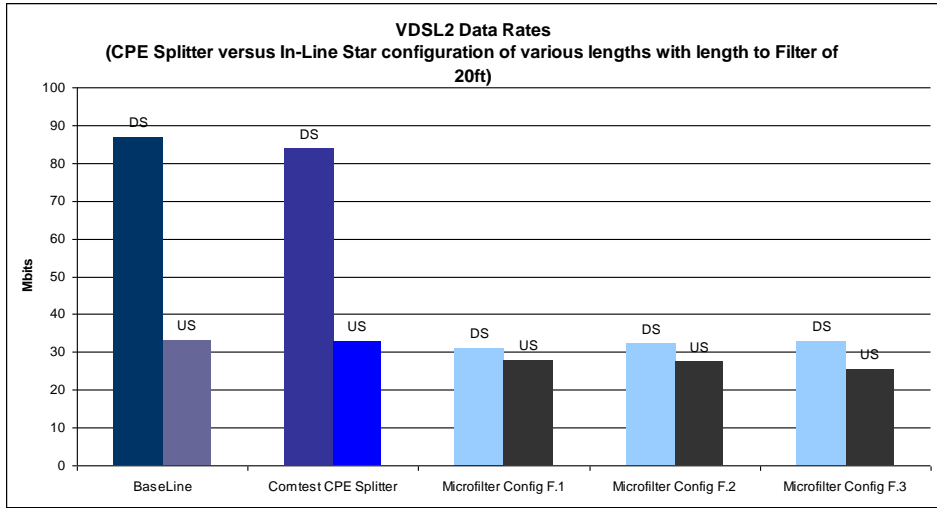

- NID-01V B NID-01V splitter placed at beginning of star TAP home run configuration. TAPs extends from POTS port of NID-01V. DSL Modem is home run from DSL Port
- Config F 5 TAP home run configuration with in-line filters on each end. 20 ft length taps

* See Appendix B Star – 20 foot phone lines for details on Configurations

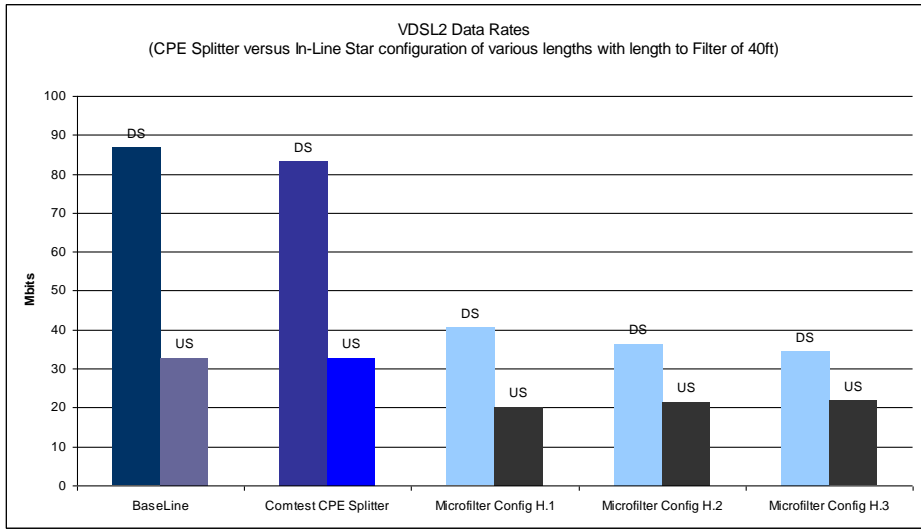

- NID-01V C NID-01V splitter placed at beginning of star TAP home run configuration. TAPs extends from POTS port of NID-01V. DSL Modem is home run from DSL Port
- Config H 5 TAP home run configuration with in-line filters on each end. 40 ft length taps

* See Appendix C Star – 40 foot phone lines for details on Configurations



VDSL2 POTS Splitters and Microfilters

Appendix A Daisy Chain Configuration

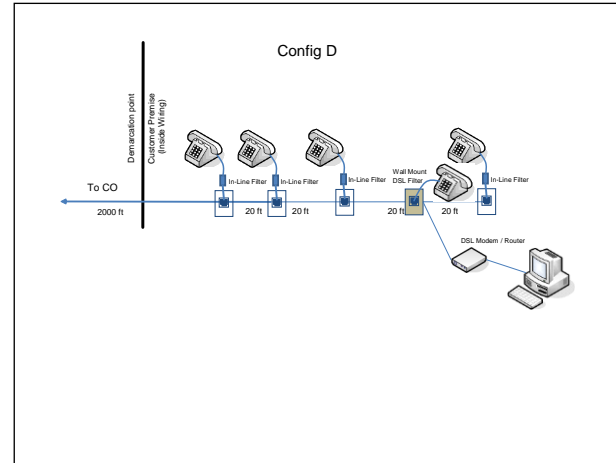
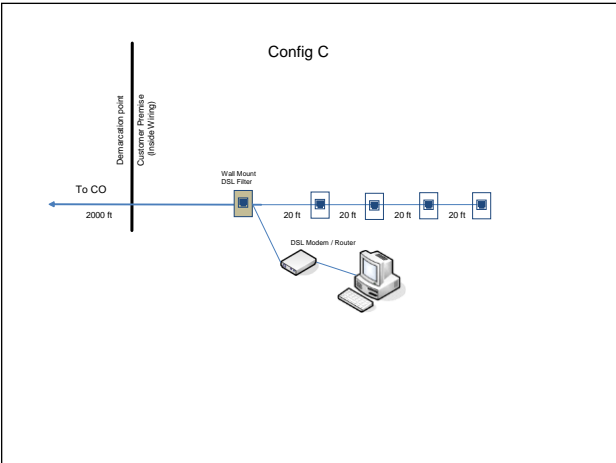
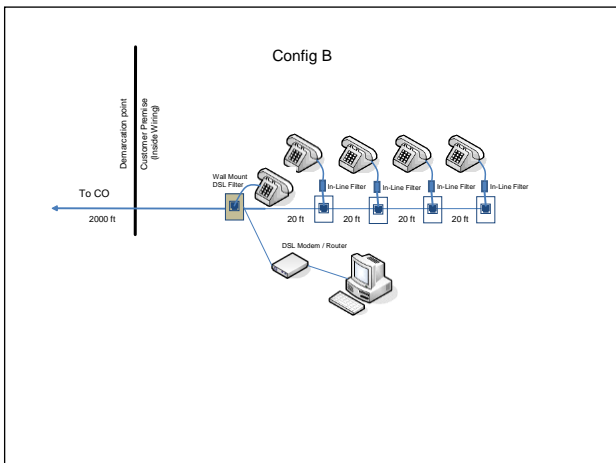
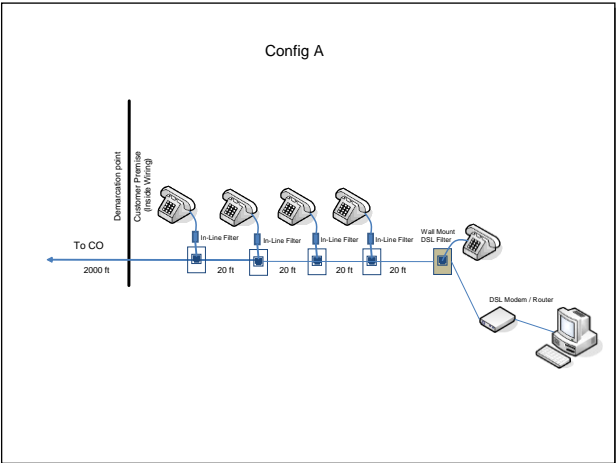
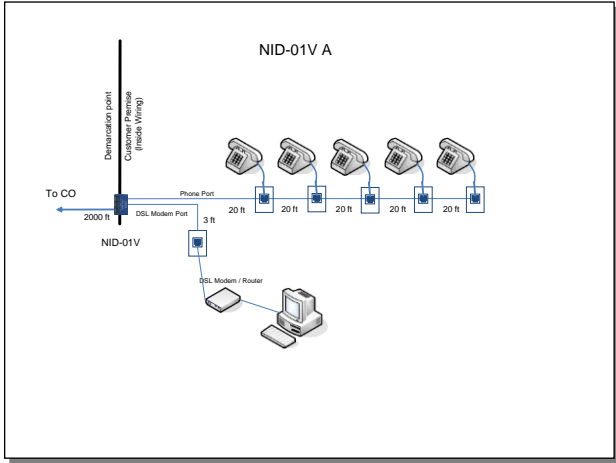
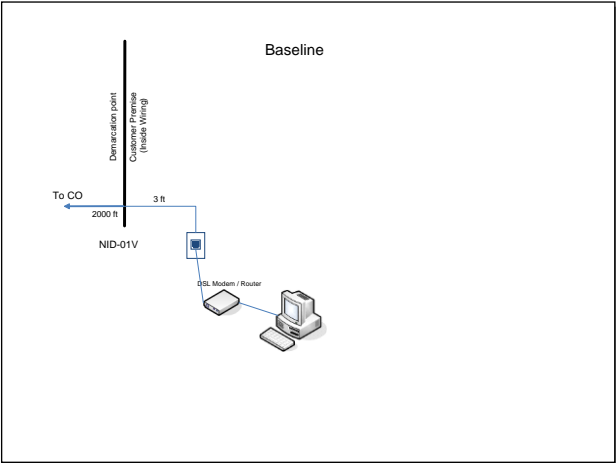



VDSL2 POTS Splitters and Microfilters

Appendix B Star – 20 foot phone lines

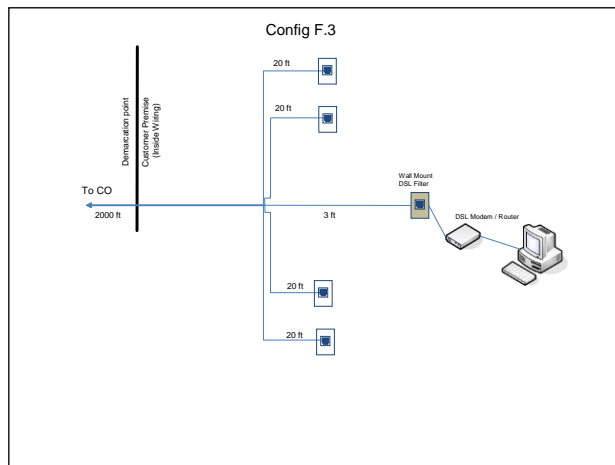
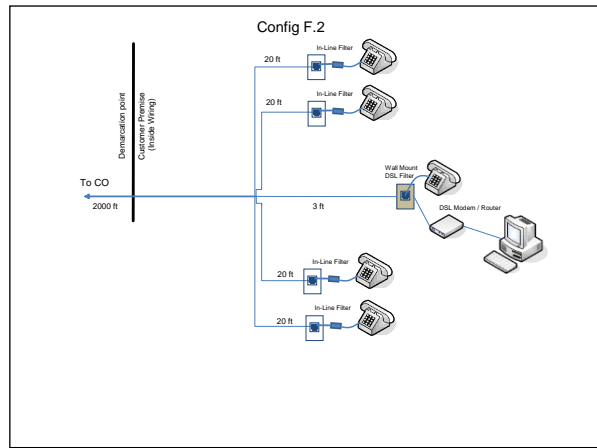
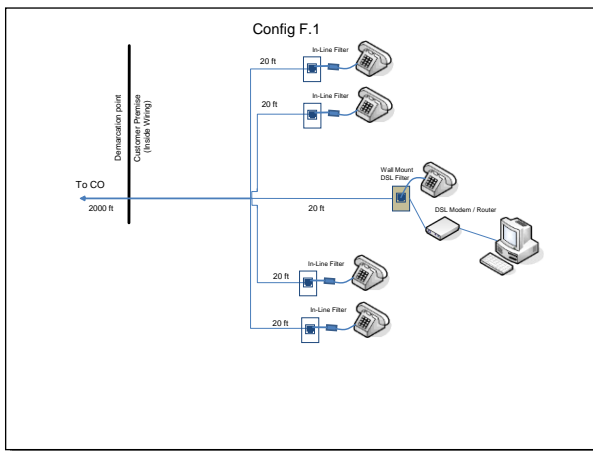
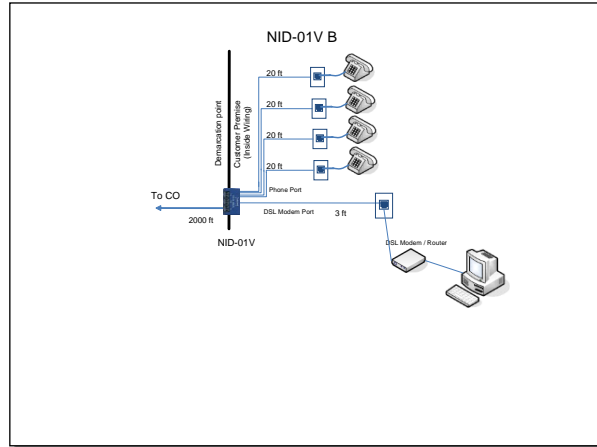
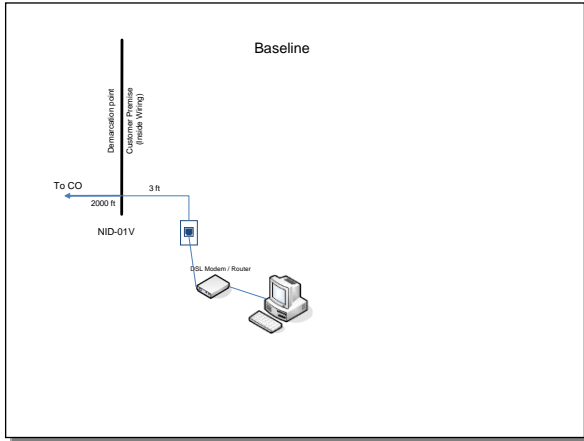

Appendix C Star – 40 foot phone lines

